

▶ FIPRES

**BOM** EVALUATION  
GUIDELINE

## ▶ STEP 1

Assessments of the electrical panel

## ▶ STEP 2

Select type of FPA

## ▶ STEP 3

Choose FPA location

STEP 3.1 FPA 24/X location

STEP 3.2 FPA 24(4S) location

## ▶ STEP 4

Choose rFPT and vFPT locations

STEP 4.1 Choose rFPT location

STEP 4.2 Choose vFPT location

## ▶ STEP 5

Select rFPT and vFPT sizes

STEP 5.1 Select rFPT size

STEP 5.2 Select vFPT size

# ▶ STEP 1. ASSESSMENTS OF THE ELECTRICAL PANEL

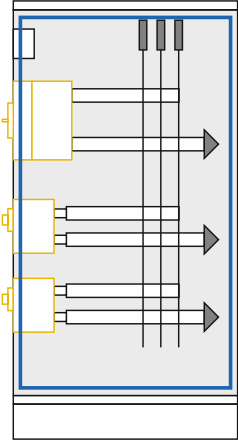
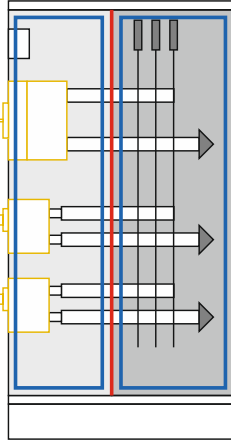
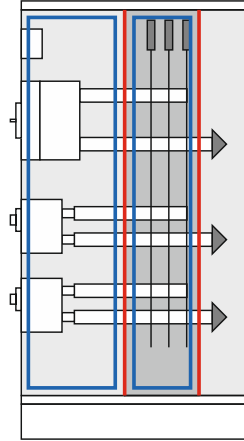
Forms of segregation		
Form 1	Form 2a	Form 2b
 <p>Form 1 does not require any separation between the components inside the enclosure.</p>	 <p>Separation of busbars from functional units. Terminals for external conductors do not need to be separated from busbars.</p>	 <p>Separation of busbars from functional units. Terminals for external conductors are separated from busbars.</p>

— **Compartment** is a closed protected volume.

# ► STEP 1. ASSESSMENTS OF THE ELECTRICAL PANEL

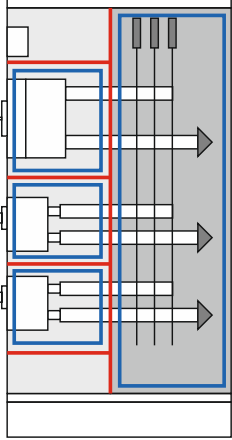
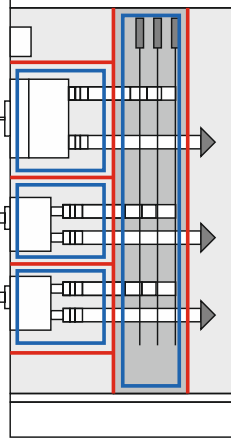
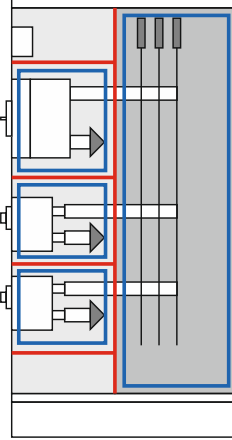
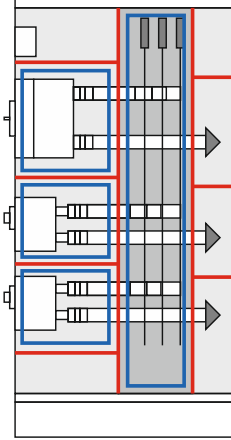
Forms of segregation			
Form 3a	Form 3b	Form 4a	Form 4b
 <p>Separation of busbars from functional units and separation of all functional units from each other.</p> <p>Terminals for external conductors are not separated from busbars.</p>	 <p>Separation of busbars from functional units and separation of all functional units from each other.</p> <p>Terminals for external conductors are separated from busbars.</p>	 <p>Separation of busbars from functional units and separation of all functional units from each other including the terminals for external conductors which are an integral part of the functional unit.</p> <p>Terminals for external conductors are in the same compartment as the functional unit.</p>	 <p>Separation of busbars from functional units and separation of all the functional units from each other including terminals for external conductors.</p> <p>Terminals for external conductors are not in the same compartment as the functional unit but in separate individual compartments.</p>

**Compartment** is a closed protected volume. Device (functional unit) is isolated in a compartment that protects it from the effects of incidents that may occur on another device (functional unit).

# ▶ STEP 1. ASSESSMENTS OF THE ELECTRICAL PANEL

rFPT + FPA

If the electrical panel has enclosed volume  
(walls are on each side)  
and natural ventilation – use **rFPT + FPA**

AND

If no force ventilation OR Forced ventilation air renewal  
per minute is less than 1 – use **rFPT + FPA**

vFPT

If the electrical panel has an open volume  
(one or more walls are missing) –  
install **vFPT**

OR

If it has forced ventilation in an enclosed volume  
(one or more walls are missing) with air renewal  
per minute is more than 1 – install **vFPT**

$$\text{Airrenewal/min} = \frac{\text{Airflow of the fan } \frac{\text{m}^3}{\text{min}}}{\text{Volume of panel } (\text{m}^3)}$$

\*the exact location of the sensors in the electrical panel can be selected using Testing kit

# ▶ STEP 2. SELECT TYPE OF FPA

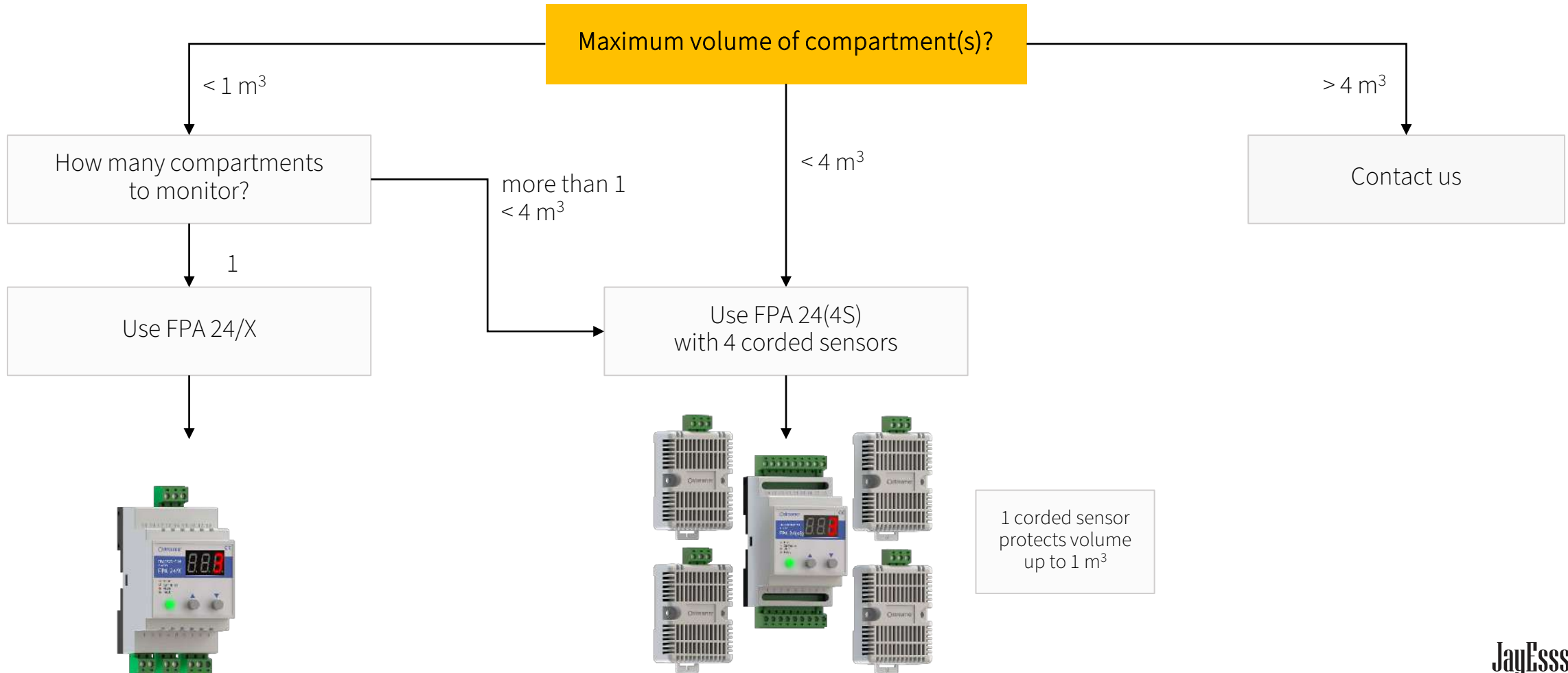

# ▶ STEP 3. CHOOSE FPA LOCATION. FPA 24/X LOCATION

1. FPA 24/X should be placed at the top part of a compartment, because the signal gas is lighter than air when it's being released and moves from bottom-to-top direction.
2. Each closed protected volume (compartment) where are rFPTs should be equipped with FPA 24/X.
3. It's recommended to install FPA 24/X near and above to rFPT spots.
4. FPA 24/X shouldn't be blocked by obstacles, which prevent spreading gas into FPA.
5. Other installation nuances such as left or right location should be considered only in terms of convenience of installation and cable-management.



main body of FPA 24/X



rFPT

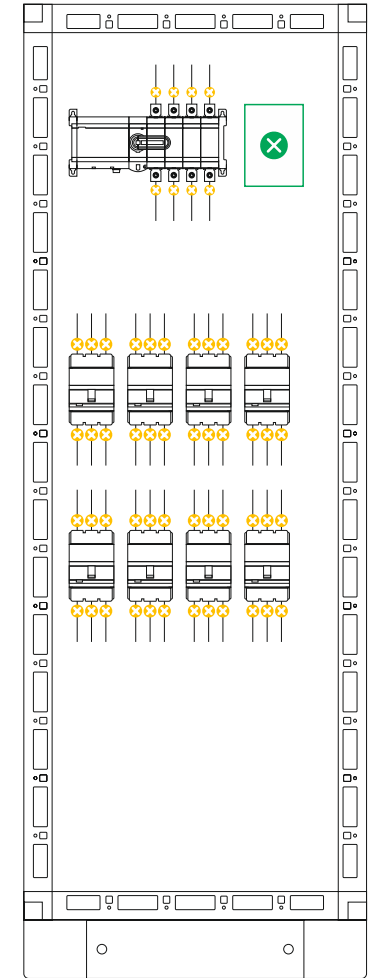
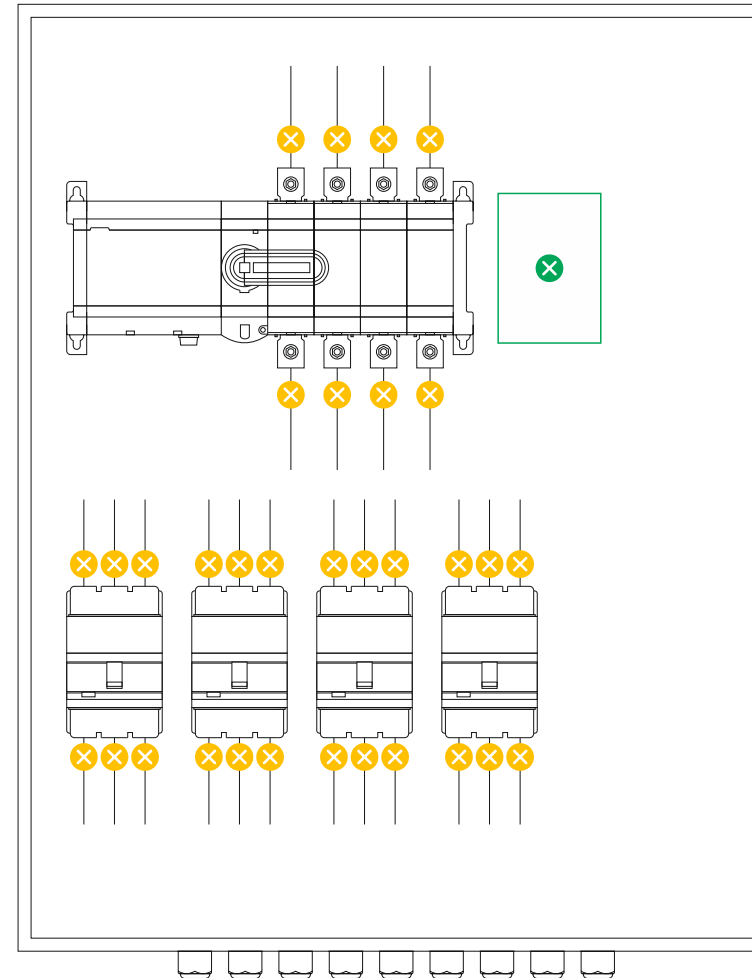

# ► STEP 3.2 FPA 24(4S) LOCATION

Switchgear with several compartments

1. Each closed protected volume (compartment) where are rFPTs should be equipped with corded sensor of FPA 24(4S).
2. Maximum volume of compartment to be equipped with one corded sensor is 1 m<sup>3</sup>. In case of volume of compartment exceed 1 m<sup>3</sup> two or more corded sensors are required.
3. Corded sensors of FPA 24(4S) should be placed at the top part of a compartment.
4. Corded sensors of FPA 24(4S) shouldn't be blocked by obstacles, which prevent spreading gas into it.
5. It's recommended to install corded sensors near and above to rFPT spots.



corded sensor



main body of FPA 24(4S)



rFPT

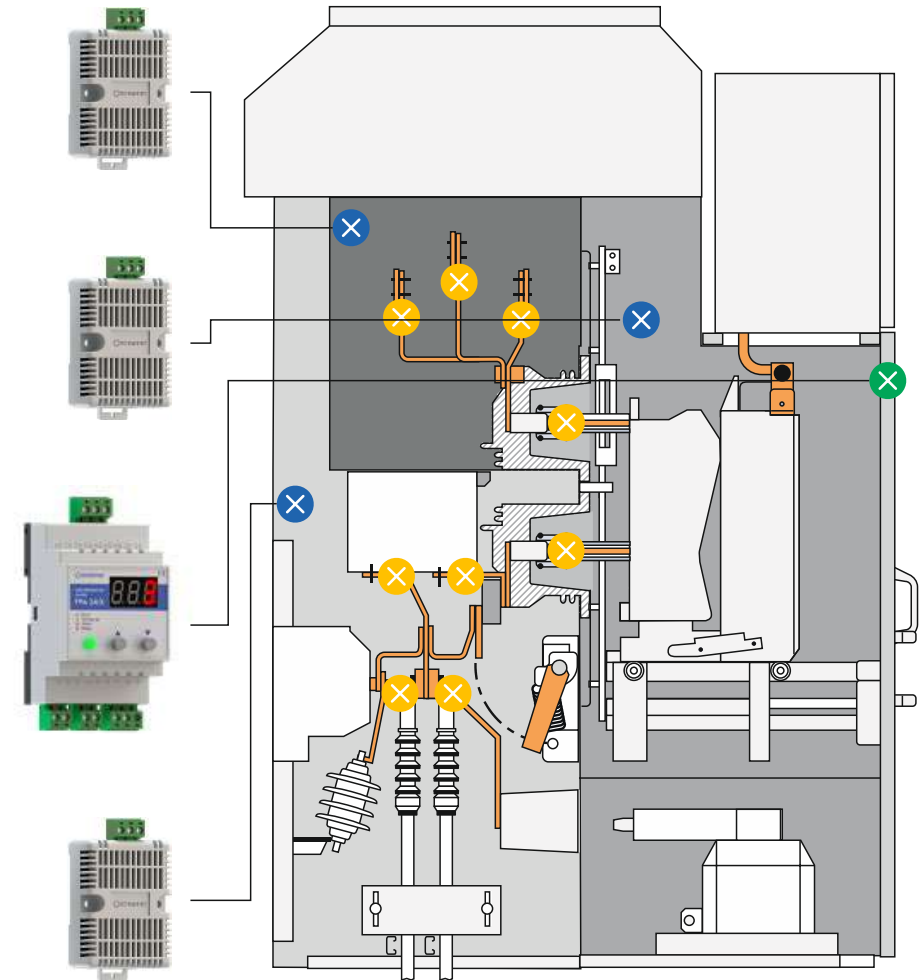



# ▶ STEP 3. FPA 24(4S) LOCATION

Panel with separated compartments with <math> < 1 \text{ m}^3 </math> of volume each

6. It's allowed to install not all 4 corded sensors (e.g., only 2 or 3) if it's acceptable for equipment layout.
7. Main body of FPA 24(4S) could be installed outside if needed cabinet or inside compartment or in any easily accessible and suitable place in other panels.
8. Other installation nuances such as left or right location should be considered only in terms of convenience of installation and cable-management.



corded sensor



main body of FPA 24(4S)



rFPT

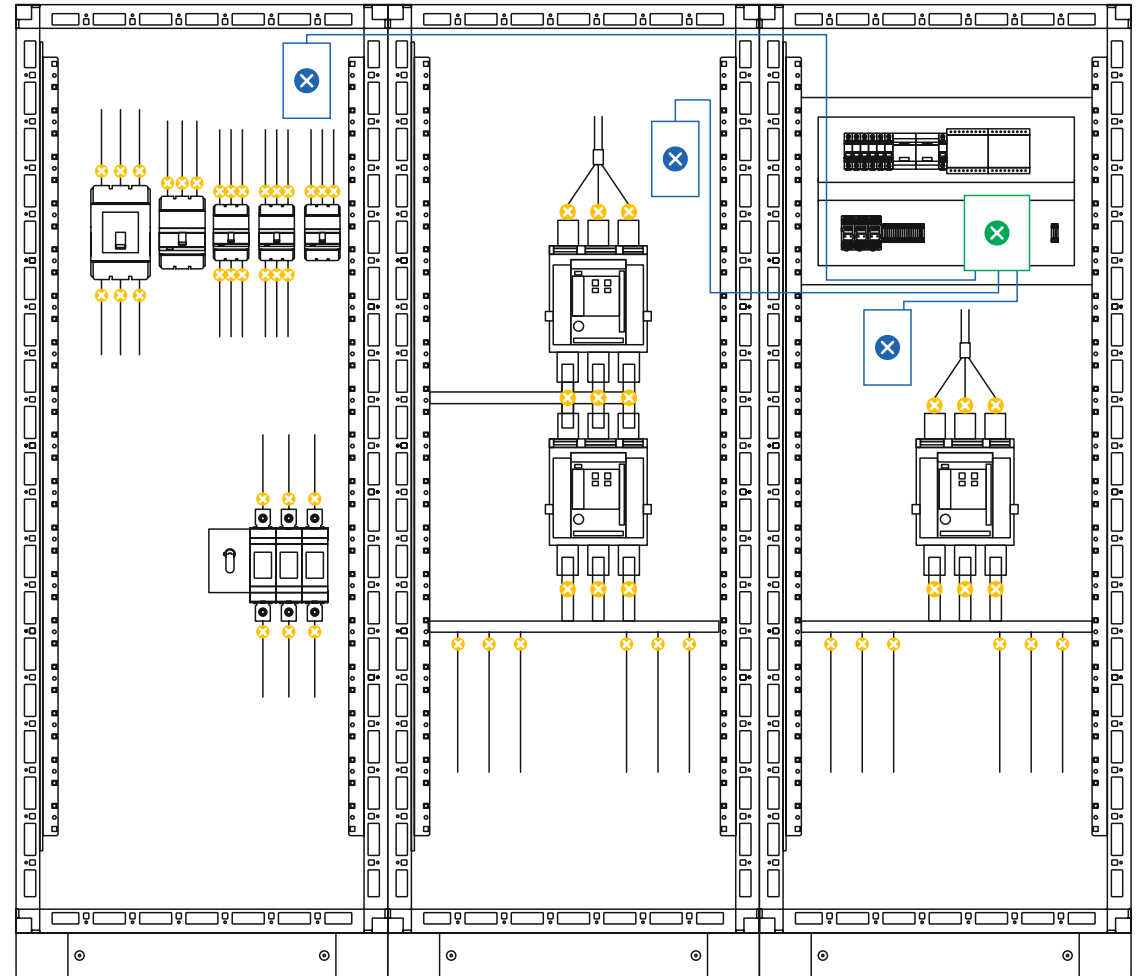

# SPECIAL CASE WITH MERGED COMPARTMENTS WITHOUT INTERNAL PARTITIONS

Panel with merged compartments without internal partitions  
with  $< 4 \text{ m}^3$  of volume each

- For the case with merged compartments without internal partitions it's necessary to install FPA 24(4S).
- It's very important to place corded sensors near to the spots of rFPTs.
- It's also needed to consider that due to the spread of gas, FPA can be triggered in an adjacent compartment.

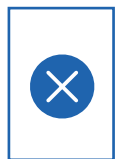

coded sensor



main body of FPA 24(4S)



rFPT

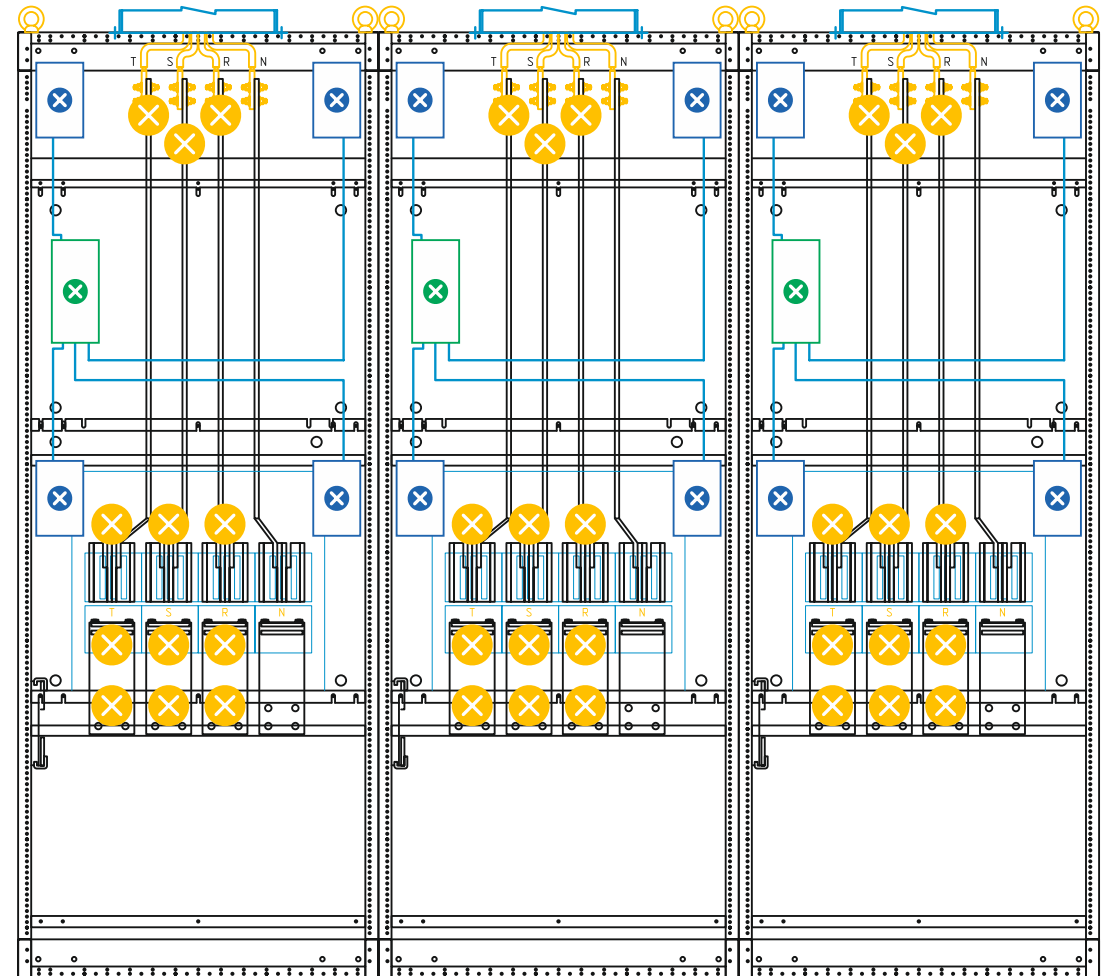

# ► STEP 4. CHOOSE rFPT AND vFPT LOCATIONS

Prioritize the equipment in the electrical panel:

## 1st PRIORITY:

1. Incoming cable contacts.
2. Circuit Breaker (CB) contacts (especially with withdrawable contacts)
3. Cable joints (incoming cables / cable feeders).
4. Fuses contacts.
5. Disconnecter contacts.

## 2nd PRIORITY:

1. Voltage transformers.
2. Busbar-busbar connections.
3. Current transformers contacts.



Incoming cable contacts, cable joints (incoming cables / cable feeders) are the contacts that made on-site, they may become loosened due to improper tightening torque during assembly, corrosion or temperature cycling through the day. Withdrawable contacts (CB, disconnecter) are subject to vibration and mechanical wear that led to a worsening of the contact condition. Fuses contacts can be overheated significantly due to the principle of operation.

# ▶ STEP 4.1 CHOOSE rFPT LOCATION

rFPTs should be installed:

- on incoming cables near connection points;
- on the terminal and bolted connections of the control wiring;
- on terminal boxes;
- on electric busbars near contact points;
- on all main circuit connection points (switchers, CBs, fuses, current and voltage transformers);
- on the housing of electrical apparatus;
- other points if it's required.

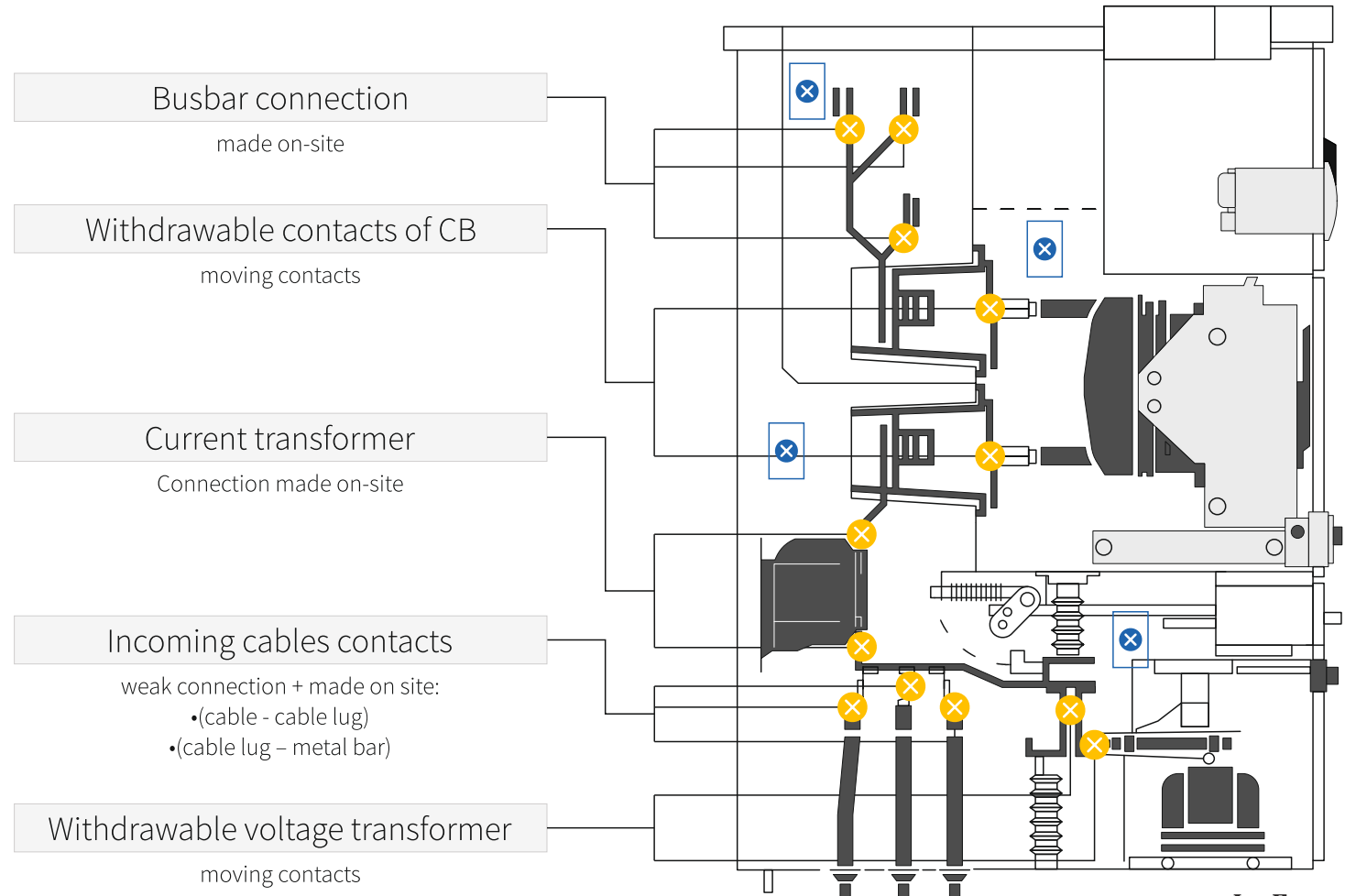
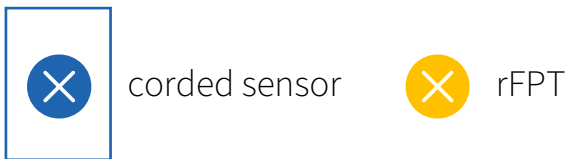

## ▶ STEP 4.2 CHOOSE vFPT LOCATIONS

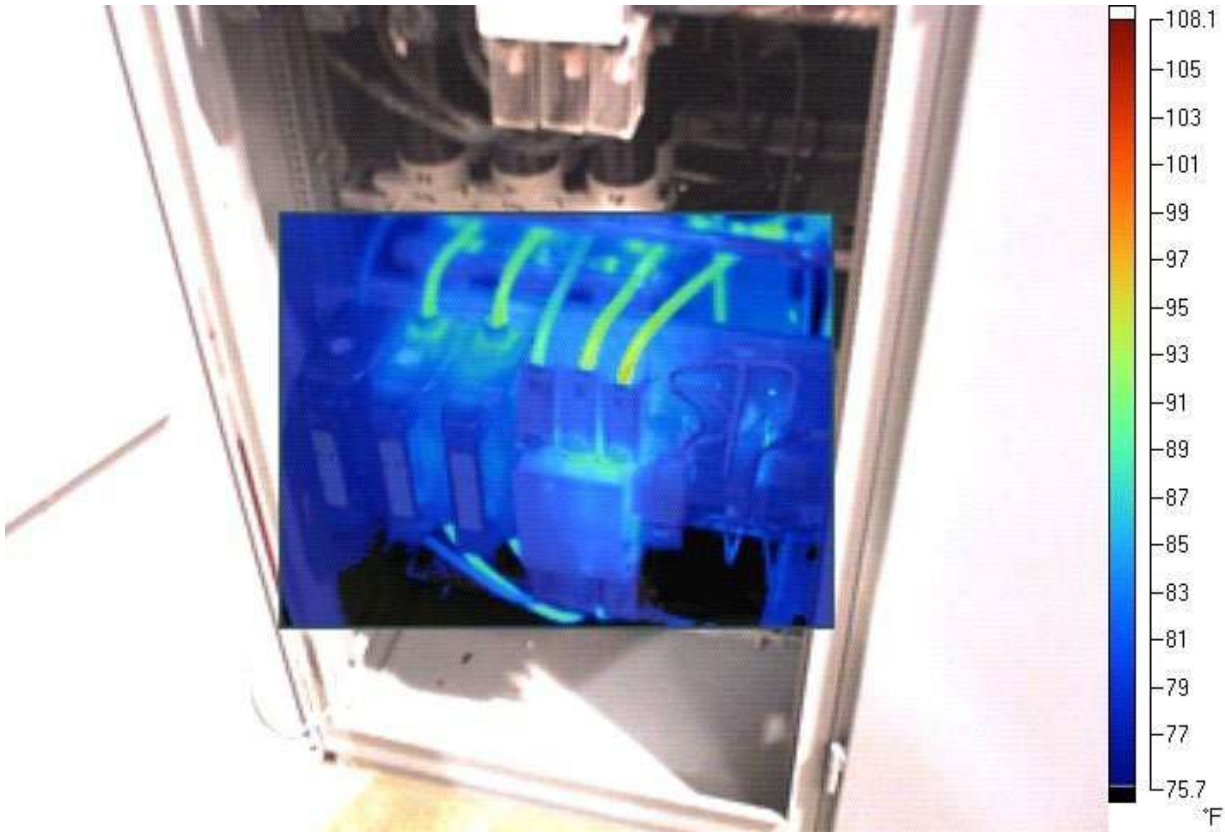

Thermal image of the capacitors

- vFPT should be installed if it's an open cabinet (one or more walls are missing) or it's a cabinet with forced ventilation.

Regular visual inspections should be provided

## ► STEP 4.2 CHOOSE vFPT LOCATIONS



Damage to circuit breaker feeding a capacitor bank. A thermal examination would have detected abnormal heating



Installation of vFPTs on the capacitors

- In case of special requirements, when the operating temperature of rFPT (80/100/130) degrees is unacceptable for the equipment and it is necessary to control a lower temperature overheating (70 degree) and regular visual inspection is provided
- In case rFPT cannot be installed due to small cross-section of the cable (compatibility of rFPT size - cable size - compartment volume is further in presentation)

# ► STEP 5. SELECT rFPT AND vFPT SIZES

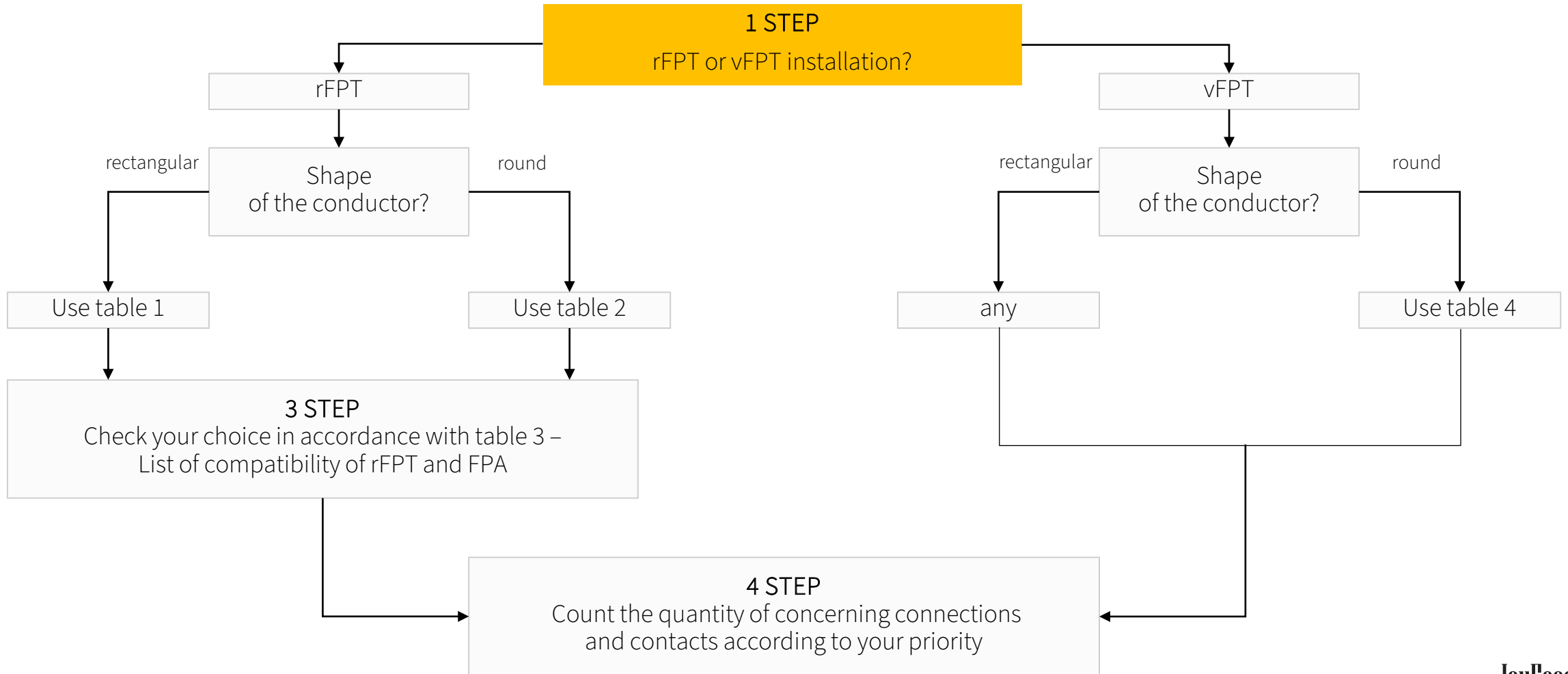

# ► STEP 5.1 SELECT rFPT SIZE BUSBAR

Table 1 - Busbar or rectangular cross-section dimension and rFPT correspondence

Busbar cross-section, mm	rFPT				
	0.1 m <sup>3</sup> (50 mm)	0.3 m <sup>3</sup> (80 mm)	1 m <sup>3</sup> (138 mm)	XL (1-4 m <sup>3</sup> ) (210 mm)	2 x XL (1-4 m <sup>3</sup> ) (320 mm)
15 x 3	+	+	—	—	—
20 x 3	+	+	—	—	—
25 x 3	—	+	+	—	—
30 x 4	—	+	+	—	—
40 x 4	—	—	+	+	—
40 x 5	—	—	+	+	—
50 x 5	—	—	+	+	—
50 x 6	—	—	+	+	—
60 x 6	—	—	—	+	—
60 x 8	—	—	—	+	—
60 x 10	—	—	—	+	—
80 x 6	—	—	—	+	—
80 x 8	—	—	—	+	—
80 x 10	—	—	—	+	—
100 x 6	—	—	—	—	+
100 x 8	—	—	—	—	+
100 x 10	—	—	—	—	+
120 x 8	—	—	—	—	+
120 x 10	—	—	—	—	+
150 x 10	—	—	—	—	+



# ▶ STEP 5.1 SELECT rFPT SIZE

2x rFPT XL length extension – rFPTs are glued on top of each other

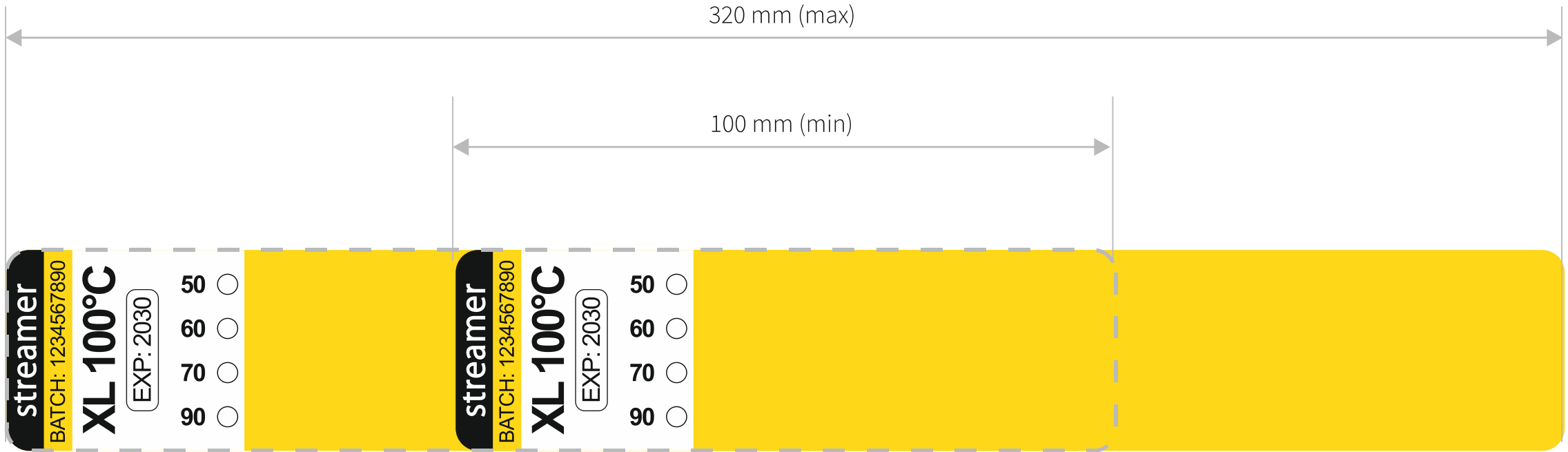

## ► STEP 5.1 SELECT rFPT SIZE

rFPT installation. In case more than 1 busbar goes per 1 phase – wrap rFPT around each busbar.



# ► STEP 5.1 SELECT rFPT SIZE CABLES

Table 2 - Cable cross-section dimension and rFPT correspondence

Cable cross-section, mm <sup>2</sup>	rFPT			
	0.1 m <sup>3</sup> (50 mm)	0.3 m <sup>3</sup> (80 mm)	1 m <sup>3</sup> (138 mm)	XL (1-4 m <sup>3</sup> ) (210 mm)
1,5	+	—	—	—
2,5	+	—	—	—
4	+	—	—	—
6	+	+	—	—
10	+	+	—	—
16	+	+	—	—
25	+	+	+	—
35	+	+	+	—
50	+	+	+	—
70	—	+	+	—
95	—	+	+	+
120	—	+	+	+
150	—	—	—	+
185	—	—	—	+

## ▶ STEP 5.1 SELECT rFPT SIZE CABLES



### rFPT installation

- Wrap in a “ring”;
- Not more than 2 layers;
- Not scratching round dots;
- The sticker must be installed so that the white part is visible to service personnel (for further inspections).

# ▶ STEP 5.1 SELECT rFPT SIZE

Table 3 - List of compatibility of rFPT and FPA

Volume of compartment, m <sup>3</sup>	rFPT 0.1	rFPT 0.3	rFPT 1	rFPT XL 2x rFPT XL	FPA 24/X	FPA 24(4S)
up to 0.1	+	+	+	+	+	+
0.11 - 0.3	— (use vFPT)	+	+	+	+	+
0.31 - 1	— (use vFPT)	— (use vFPT)	+	+	+	+
1.01 - 4	— (use vFPT)	— (use vFPT)	— (use vFPT)	+	—	+

+	recommended solution	— (use vFPT)	use vFPT or consult us
+	acceptable solution	—	unacceptable solution

# ▶ STEP 5.1 SELECT vFPT SIZE

Table 4 - Conductor cross-section dimension and vFPT correspondence

Size	S	M	L
Length, mm	42	57	82
Width, mm	16	16	16
Conductor cross-section, mm <sup>2</sup>	up to 10	10-35	35-120
Bus-bar dimension	any		



# ▶ STEP 5.1 SELECT vFPT SIZE

Table 5 - Conductor cross-section dimension and vFPT correspondence

Length, mm	50
Width, mm	20
Conductor cross-section, mm <sup>2</sup>	10-120
Bus-bar dimension	any
Standard range vFPT	FP.VT.058C.Y1.WW — 50-60-70-80 °C FP.VT.811C.Y1.WW — 80-90-100-110 °C Other set of temperatures can be created on request with a minimum order quantity
Possible temperature ranges, °C	50, 60, 70 ,80, 90, 100, 110, 120

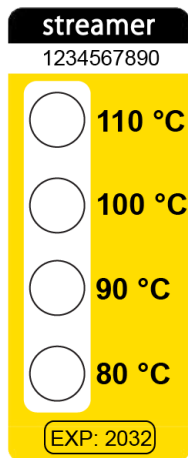
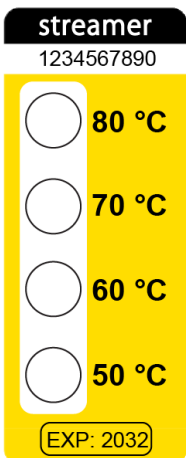

# ► BOM EXAMPLE 1

## MV compartments

1. busbars for cubicle interconnection
2. withdrawable circuit breaker
3. incoming cables
4. earthing switch
5. current transformer
6. voltage transformers (optionally equipped with withdrawable fuses)

## LV control cabinet

7. low voltage compartment

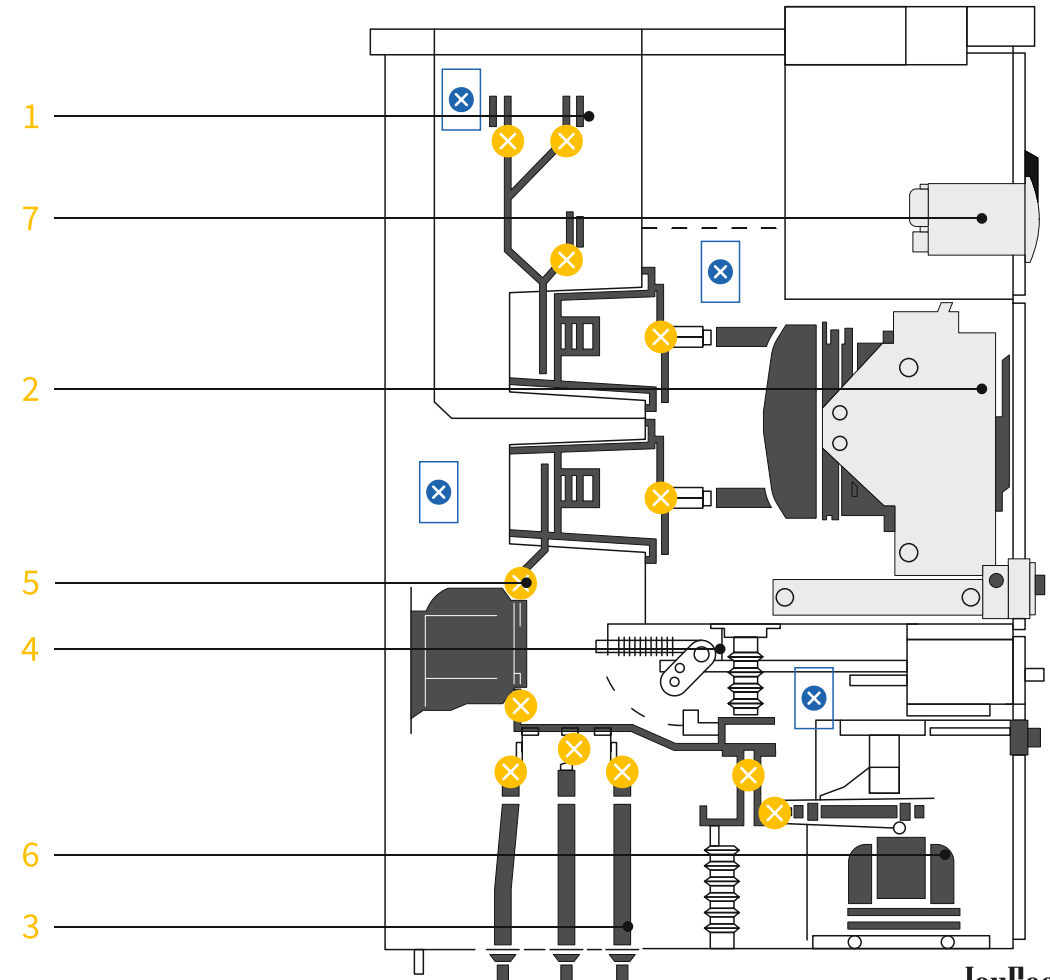
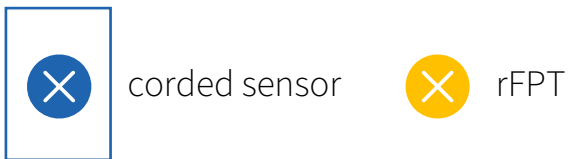



# ► BOM TABLE EXAMPLE 1





Table 6 - BOM table example 1

STEP 1		STEP 2		STEP 3	
Select type of FPA	V of compartment	Choose rFPT and vFPT locations		Select rFPT/vFPT sizes according to tables 1-4	
2 m <sup>3</sup> 4 compartments FPA 24 (4S)  4 corded sensors in 4 compartments	0.7 m <sup>3</sup>	Incoming cables. 3 cables	3 rFPT	120 mm <sup>2</sup>	rFPT 100 XL (according to table 2)
		Current transformer. 6 contacts	6 rFPT	50x6 mm	rFPT 100 XL (according to table 1)
		Auxiliary contact (b/w incoming cables and voltage transformer). 3 contacts	6 rFPT	50x6 mm	rFPT 100 XL (according to table 1)
	0.3 m <sup>3</sup>	Voltage transformer. 6 contacts	3 rFPT	50x6 mm	rFPT 100 XL (according to table 1)
	0.7 m <sup>3</sup>	Circuit breaker with withdrawable contacts. 6 contacts	6 rFPT	10 mm of diameter	2x rFPT 100 XL = 12 rFPT 100 XL (according to table 2)
	0.3 m <sup>3</sup>	Busbar feeders. 3 busbars	3 rFPT	60x10 mm	rFPT 100 XL (according to table 1)

Nº	Product	Qty
1	rFPT 100 XL	33 pcs
2	FPA 24 (4S)	1 pcs

# ▶ BOM EXAMPLE 2

Dimension (DB)	1600W x 2100H x 6500 mm
Enclosure	IP-31
Type	Form-2
Paint	Epoxy powder coating
Casing colour code	Ral 7035
Partition colour code	Ral 7035
Frame thickness	14 SWG steel sheet
Door thickness	16 SWG steel sheet
Cover thickness	16 SWG steel sheet
Weight	1000 Kg
Incoming cable access	Top
Outgoing cable access	Bottom
Grand plate	2 mm metal plate
Access	Front

-  corded sensor of FPA 24(4S)
-  vFPT 90S
-  rFPT 100/0.3
-  rFPT 100 XL

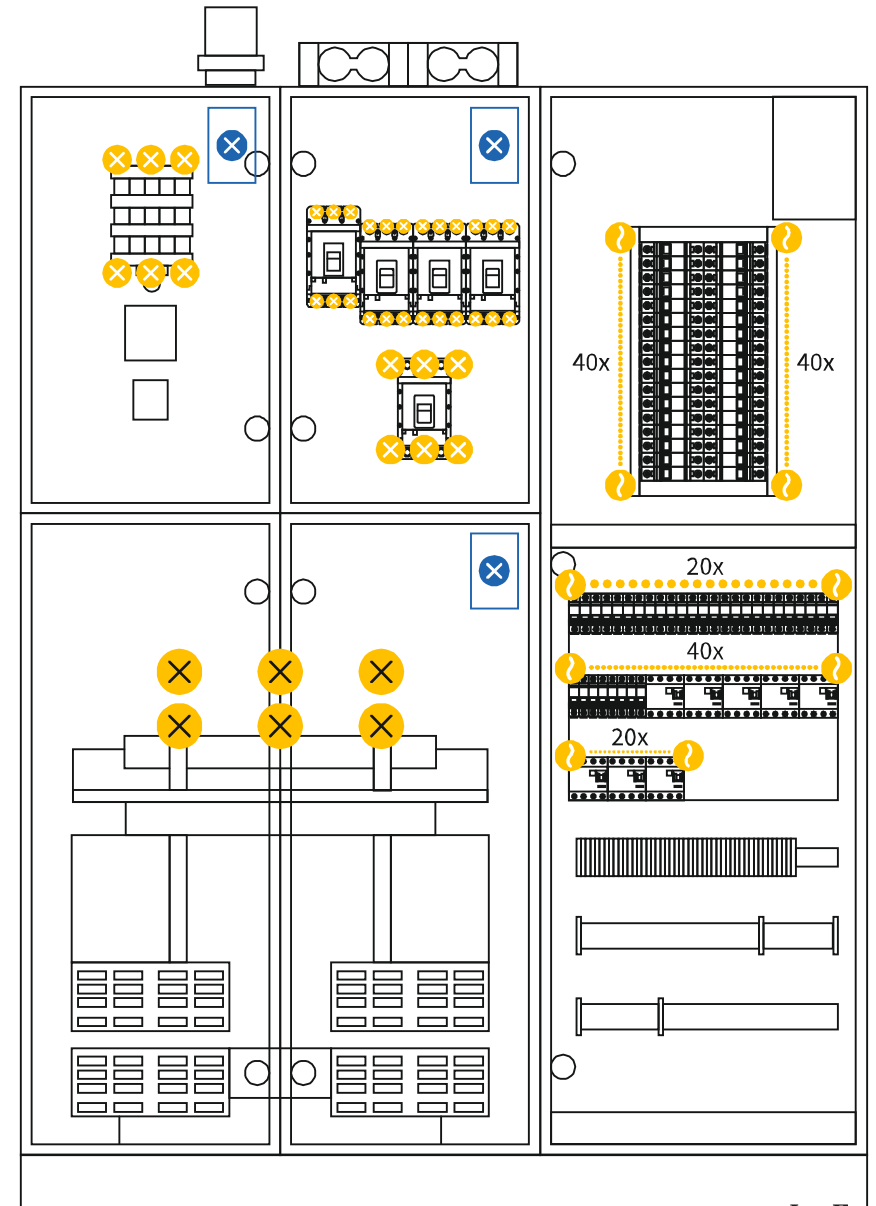

# ► BOM TABLE EXAMPLE 2

Table 7 - BOM table example 2

STEP 1		STEP 2		STEP 3	
Select type of FPA	V of compartment	Choose rFPT and vFPT locations		Select rFPT and vFPT sizes according to table 1, 2, 3, 4	
2.2 m <sup>3</sup> 4 compartments  FPA 24 (4S)  3 corded sensor in 3 compartments	0.78 m <sup>3</sup>	Transformer. 6 contacts	6 rFPT	50x5 mm	rFPT 100 XL (according to table 1)
	0.26 m <sup>3</sup>	Busbar feeders. 6 contacts	6 rFPT	30x4 mm	rFPT 100/0.3 (according to table 1)
	0.26 m <sup>3</sup>	MCCB. 24 contacts	24 rFPT	6 mm <sup>2</sup>	rFPT 100/0.3 (according to table 2)
		CB. 6 contacts	6 rFPT	25 mm <sup>2</sup>	rFPT 100/0.3 (according to table 2)
	0.82 m <sup>3</sup>	MCB. 100 contacts	100 rFPT	1.5 mm <sup>2</sup>	vFPT 90S (according to table 3 and 4)
		RCCB. 60 contacts	60 rFPT	1.5 mm <sup>2</sup>	vFPT 90S (according to table 3 and 4)

Nº	Product	Qty
1	rFPT 100 XL	6 pcs
2	rFPT 100/0.3	36 pcs
3	FPA 24 (4S)	1 pcs
4	vFPT 90S	160 pcs

# WHAT SHOULD YOU ASK THE CLIENT TO PROVIDE TO MAKE CORRECT AND ACCURATE TECH QUOTATION?

Photos of the panels inside so that all equipment could be visible with the dimensions of the panel

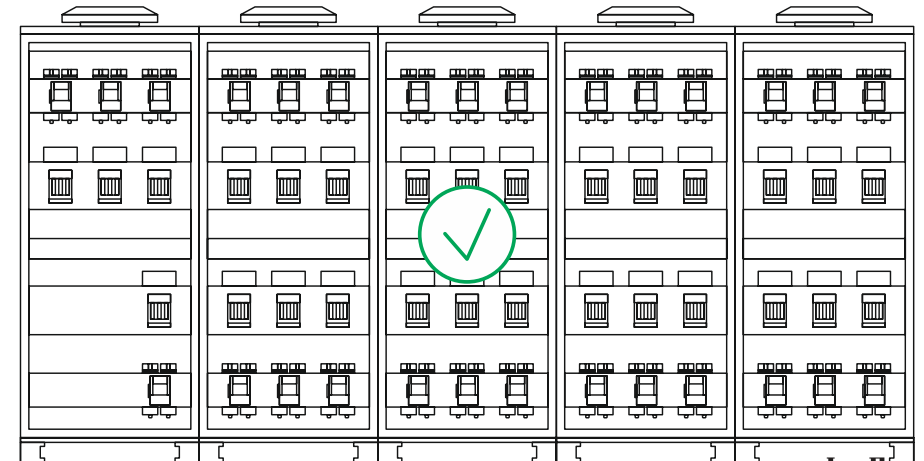
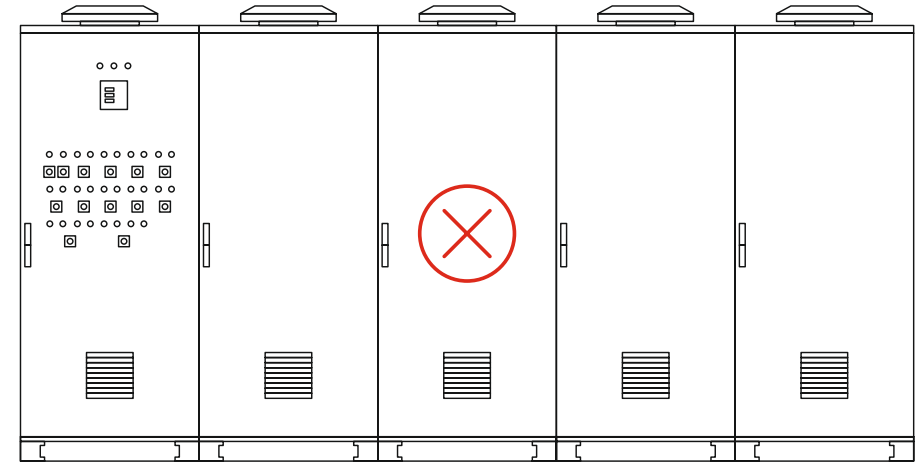

Good technical drawings with the inside information:

- The dimension of the panel and whether it's separated inside into different compartments or not
- The sizes of busbars and cables and their location

# WHAT SHOULD YOU ASK THE CLIENT TO PROVIDE TO MAKE CORRECT AND ACCURATE TECH QUOTATION?



The perfect case is when both photos and technical drawings are provided!

Good technical drawings with the inside information:

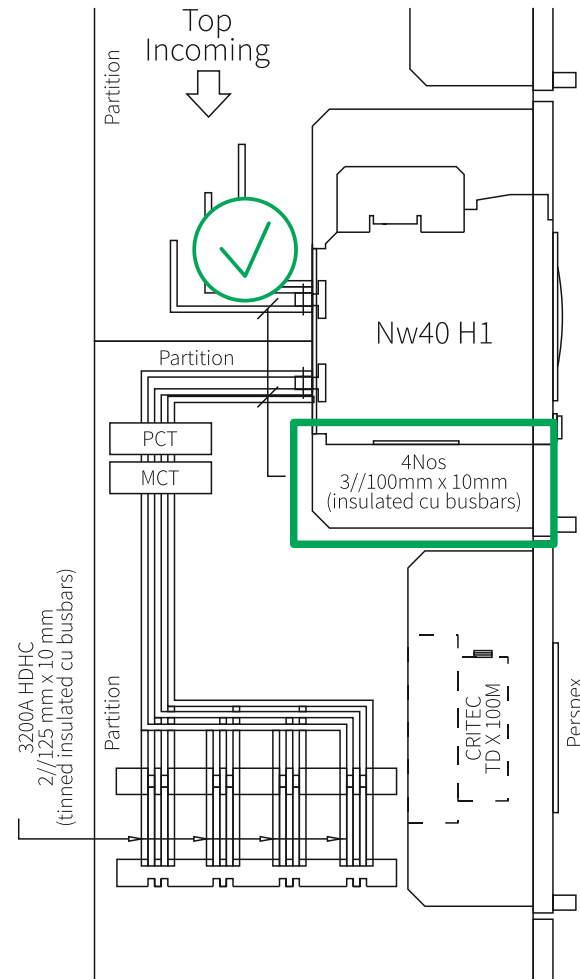
- The dimension of the panel and whether it's separated inside into different compartments or not
- The sizes of busbars and cables and their location



CLICK ON THE ICONS TO  
VISIT OUR SOCIAL NETWORKS

 /jayessspvtltd  
 /jayessspvtltd



LEARN MORE ABOUT THE PRODUCT ON THE  
WEB-SITE SECTION DEDICATED TO FIPRES



ALSO CHECK OUT OUR 8 MINUTES  
CARTOON ABOUT FIPRES ON YOUTUBE



*Authorized Distributor in Pakistan*

**JayEsss**  
Private Limited

+92 303 9722 204 @ www.JayEsss.com Info@JayEsss.com

***Karachi Office :***

C T Tower, Building # 58 - C,  
11th Commercial Street,  
DHA Phase II Extension,  
Karachi - 75500

***Islamabad Office :***

# 45,  
Bhittai Road,  
F - 7 / 1,  
Islamabad, Pakistan

***Lahore Office :***

# 66 - P, Mini Market,  
Gulberg II,  
Lahore, Pakistan